



# HOW TO INSTALL YOUR AUTOMATIC ICE MAKER



## ECKMF-86

**KEEP ALL PARTS IN THEIR OWN PACKAGE UNTIL NEEDED**

PARTS ARE LISTED BY STEPS IN WHICH THEY ARE USED. ARRANGE IN ORDER BEFORE STARTING INSTALLATION. REFER TO **SERVICE PARTS LIST** FOR INDIVIDUAL REPLACEMENT PARTS.

<b>PART NUMBER</b>	<b>NAME</b>	<b>QUANTITY</b>	<b>USED IN STEP NUMBER</b>
# 1 944811	WIRING ASSEMBLY	1	4, 13
# 2 836489	WATER TUBE FITTING	1	3
# 3 470168	GRAY SEALER (PERMAGUM)	1	3
# 4 939027	WATER INLET TUBE (ALUMINUM)	1	13
# 5 489069	SCREW, STAINLESS (NO. 8 × ½")	1	15
# 6 627910	WATER VALVE ASSEMBLY	1	5, 6, 7, 9
# 7 939529	ICE BUCKET	1	15
# 8 488878	CLAMP	1	11
# 9 488645	SCREWS, SHEET METAL (NO. 8 × ½")	4	8, 9, 10, 11
#10 841707	TUBE INSERT	1	11
#11 488366	CLAMPS	2	10
#12 488649	SCREW, SELF TAPPING (NO. 8-32 × ½")	2	9
#13 549193	CLAMP	1	10
#14 946335	PLASTIC TUBE ASSEMBLY	1	6, 11
#15 627886	COPPER TUBE ASSEMBLY	1	7

# Installation Steps

These instructions cover models with and without a condenser coil on the back of the cabinet. See illustrations below and follow instructions that apply to your model.

## Tools and Other Items You Will Need

- |                             |  |
|-----------------------------|--|
| <b>Tools</b>                | <b>Water Hook Up</b>                                       |
| 1—Phillips head screwdriver | (Materials needed, not included in Ice Maker Kit.)         |
| 1—Pliers                    | 1/4" O.D. Copper Tubing—See step 2 (back page) for length. |
| 1—1/4" nut driver           | 1—Shut-off Valve—1/4" outlet.                              |
| or                          | 1—Tube Union—1/4" x 1/4"                                   |
| 6" flat blade screwdriver   |  |

## 11 Plastic Tube Connection

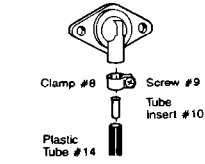

Place Clamp onto inlet tube.  
Place tube insert in end of tube and slide into inlet tube, tighten clamp.  
NOTE: Excess tube can be cut off; be sure to allow line to go into tube for full length of insert.

## 10 Attach Wire and Water Tube Clamps

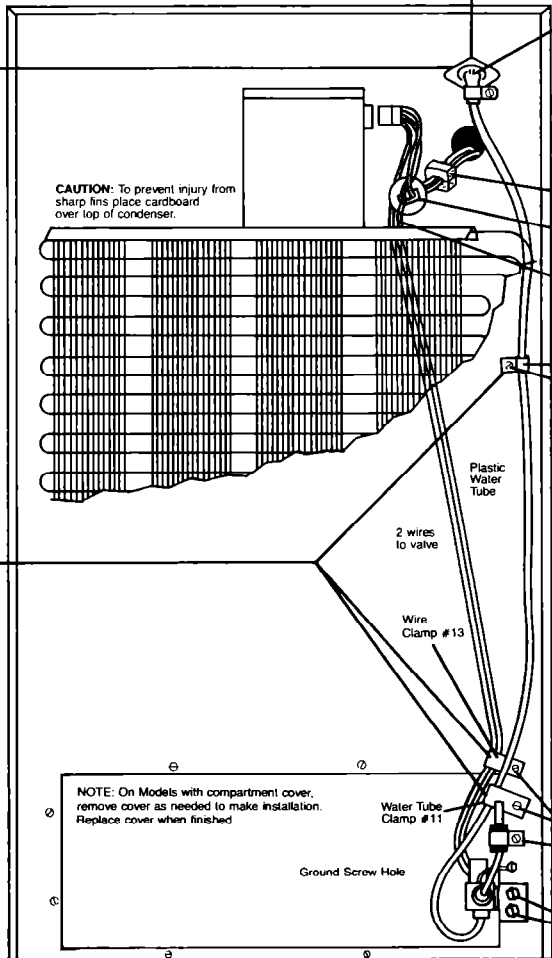

**CAUTION:** To prevent injury from sharp fins place cardboard over top of condenser.

NOTE: On Models with compartment cover, remove cover as needed to make installation. Replace cover when finished.

## 1 Unplug Electric Plug From Outlet

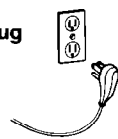

## 2 Install Water Tube

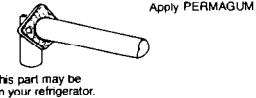

This part may be on your refrigerator.

## 3 Remove 2 Screws (save for reuse)



Remove Water Fill Cover

## 4 Install Wiring Harness

Remove wiring hole cover. Pull insert pad from cabinet hole and place around wires.  
Push wiring harness #1 into hole, being sure grommet seals flush to prevent air entry.  
Connect plug firmly into receptacle.  
Route wires behind condenser coils if present.

## INSTALL WATER VALVE

### 5 Connect valve wiring plug onto terminals on valve coil.

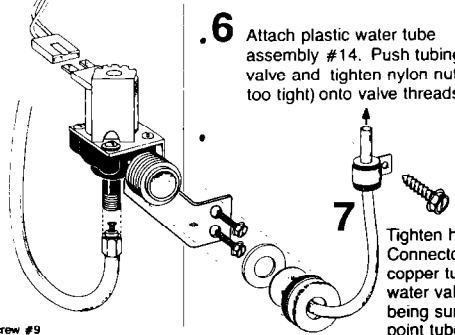

### 6 Attach plastic water tube assembly #14. Push tubing into valve and tighten nylon nut (not too tight) onto valve threads.

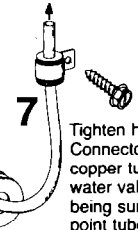

7 Tighten hose Connector of copper tube to water valve being sure to point tube straight up.

### 8 Attach clamp with Sheet Metal Screw #9.

### 9 Attach Valve with Self Tapping Screw #12.

## 12 Fill Cup

Remove knock-out from fill cup facing the back wall of freezer located on Ice Maker.

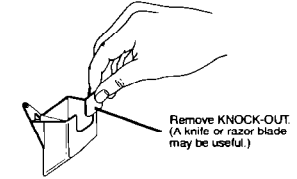

Remove KNOCK-OUT (A knife or razor blade may be useful.)

## 13 Remove Plugs and Cover from Freezer Wall

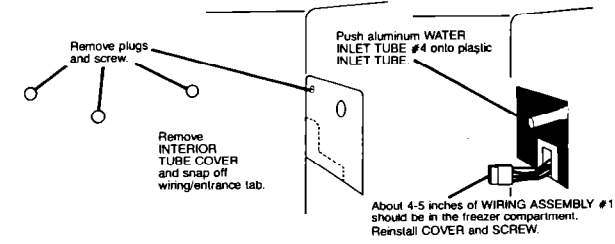

## 14 Plug-in Ice Maker

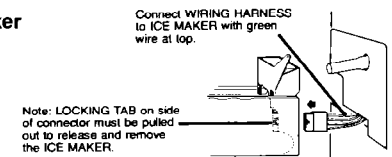

## 15 Attach Ice Maker to Freezer Wall

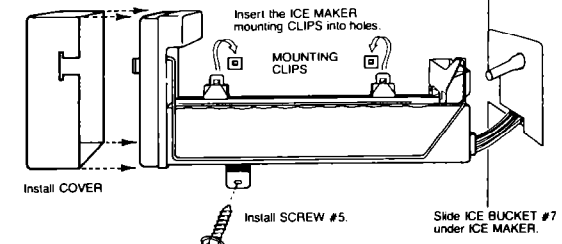

## 16 Connect Ice Maker to Water Supply

**TYPICAL WAYS TO CONNECT TO WATER SUPPLY**  
You will need enough 1/4-inch O.D. copper tubing to connect refrigerator to water source. (See step 2 on next page.)

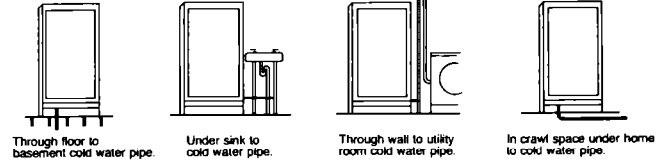

**CAUTION:** Ice maker tubing should not be installed where temperature may fall below freezing.

# Connect Ice-Maker To Water (Contd.)

1. Find a 3/8-inch to 1-inch vertical COLD water pipe near the refrigerator. (Horizontal pipe will work...but extra precautions must be taken.) (See \* in Step 4.) Connect to unsoftened water line if possible.
2. Measure from inlet on rear of refrigerator to water pipe. Add 7 feet to allow for moving refrigerator for cleaning. This is the length of 1/4-inch O.D. copper tubing you will need for the job (length from inlet tube to water pipe PLUS 7 feet). Be sure both ends of copper tubing are cut square.
3. Turn OFF main water supply. Turn ON nearest faucet long enough to clear line of water.
4. **Using a grounded drill**, drill a 1/4-inch hole in the vertical cold water pipe you have selected. **Use of self piercing valve may lead to flow problems in the future.** Some water almost always remains in pipes. If it enters the drill, it can cause lethal shock. **BE SURE YOUR DRILL IS GROUNDED.**

Fasten a separate ground wire from drill to a good ground that complies to local electrical codes. (If in doubt, consult a licensed electrician.) **UNLESS PROPER GROUNDING IS FOLLOWED, YOU ARE NOT PROTECTED AGAINST SEVERE OR LETHAL SHOCK.**

\* If you must use a horizontal pipe, take extra precautions:

**Drill on the top or side of the pipe, not bottom.** This helps keep water away from the drill. Also, it keeps normal sediment from collecting in the valve.

5. Fasten *shutoff valve* to cold water pipe with pipe clamp. Be sure *inlet end* is solidly in the 1/4-inch drilled hole in the water pipe and that *washer* is under the *pipe clamp*. Tighten packing nut. Tighten the *pipe clamp* screws carefully and evenly so *washer* makes a watertight connection. Do not overtighten or you may crush copper tubing, especially if soft copper tubing is used. Now you are ready to connect the copper tubing.

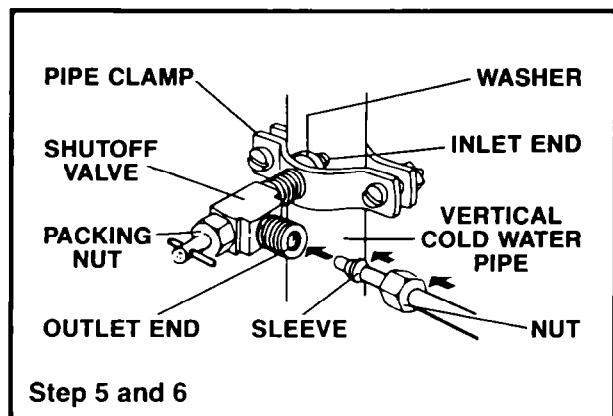

Slip *compression nut* and *compression sleeve* on copper tubing as shown in diagram. Insert end of tubing into *outlet end* squarely as far as it will go. Screw *compression nut* to *outlet end* with adjustable wrench. Do not overtighten. Turn ON main water supply and flush out tubing until water is clear. Turn

OFF *shutoff valve* on the water pipe. You are now ready to connect other end of 1/4-inch copper tubing to inlet tube or water valve on back of refrigerator.

7. Assemble *compression nuts* on tubing as shown in diagram. Insert ends of tubing into *connector* and tighten *compression nuts*. Be sure ends of tubing are squarely in connector as far as they will go. Do not overtighten.

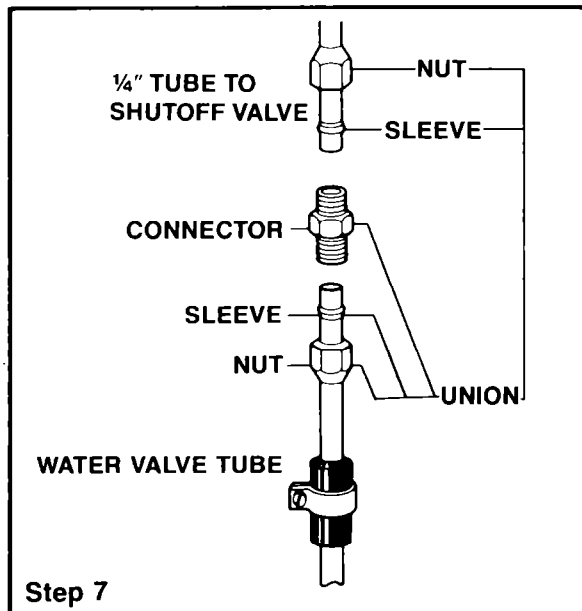

8. Turn shutoff valve on. **TIGHTEN ANY CONNECTIONS OR NUTS THAT LEAK.**
9. Copper tubing may now be fastened to baseboard.
10. The Ice Maker has a built-in water strainer on the inlet side of the water valve. Use a second water strainer when local water conditions require periodic cleaning or a well is your source of water. The strainer can be installed in the 1/4-inch water line.
11. Water pressure should not be below (15 P.S.I.) or above (125 P.S.I.). If problem occurs call your Utility Company.

## 17 Plug in your refrigerator

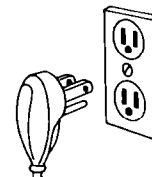

### IMPORTANT:

It may take up to 24 hours for your Ice Maker to begin producing ice crescents.

To enjoy your Ice Maker most PLEASE READ CAREFULLY THE ICE MAKER SECTION OF YOUR USE AND CARE GUIDE.